

URBAN WOOD

Postgraduate MSc Program

"Wood Based Building Design for Sustainable Urban
Development"

In cooperation with

Dresden University of Technology and the Polytechnic of Turin

"Schweighofer-Prize" in 2005,

Wood based products for multistorey buildings. The
potential application of timber-glass composite
structures for building construction

LBTGC

Load Bearing Timber Glass Composite

dr. Bruno Dujič, Iztok Šušteršič

*CBD d.o.o. - Contemporary Building Design
Lopata 19g, 3000 Celje
bruno.dujic@cbd.si
www.cbd.si*



Univerza v Ljubljani

NAMEN PROJEKTA

- Razvoj **konstrukcijskega sistema** iz lesa in stekla.
- Razvoj **konceptov**, študij **izvedljivosti** in vrednotenja **komponent**.
- Razvoj novih **računskih metod** in **optimizacija proizvodnih metod**.
- **Glavni poudarek na konstrukcijski nosilnosti stekla** – bistvena razlika glede na dosedanjo uporabo kombinacije stekla in lesa.



PARTNERJI V PROJEKTU



WoodWisdom-Net

SLOVENIJA



Univerza v Mariboru, Fakulteta za gradbeništvo

CBD d.o.o., Contemporary Building Design

Univerza v Ljubljani, Fakulteta za gradbeništvo in geodezijo

ŠVEDSKA



Glafo AB

Linneaus University

Södra Timber AB

Pilkington Floatglas AB

Sika Sverige AB

Glasbranschföreningen

NNC Construction Sverige AB

Stora Enso Timber AB

AVSTRIJA



Vienna University of Technology

Knapp Ltd

Haas Fertigbau Holzwerk GmbH & CO.

Ziviltechniker Architekt Werner Hackermüller

SIKA Österreich GmbH

Hermann Otto GmbH

BRAZILIJA



WoodMetal

Associação Escola de Cidade

Instituto de Pesquisas

Technológicas

Penha Vidros

NEMČIJA



Technische Universität Dresden

Gumpp & Maier GmbH

ČILE



P. Universidad Catolica

TURČIJA



Istanbul Technical University

Turkish Timber Association

Trakya Cam Sanayii A.S.

DELOVNE SKUPINE

1. Vodenje projekta
2. **Pregled stanja** na trgu in na razvojnem področju
3. **Arhitektura**, oblikovanje, detajli
4. Razvoj kompozitov iz lesa, stekla in lepil – **lastnosti komponent**
5. **Eksperimentalna analiza** manjših **komponent**
6. **Eksperimentalna analiza** končnih sestavljenih **elementov**
7. Konstruiranje in **računske metode**, **optimizacija** komponent
8. Testiranje elementov na **dolgotrajno obtežbo**
9. **Proizvodnja**, optimizacija procesov, **kontrola kvalitete**
10. Študije **vpliva na okolje**, **LCA analize**, končna poročila

MODELIRANJE POSAMEZNIH KONSTRUKCIJSKIH SKLOPOV

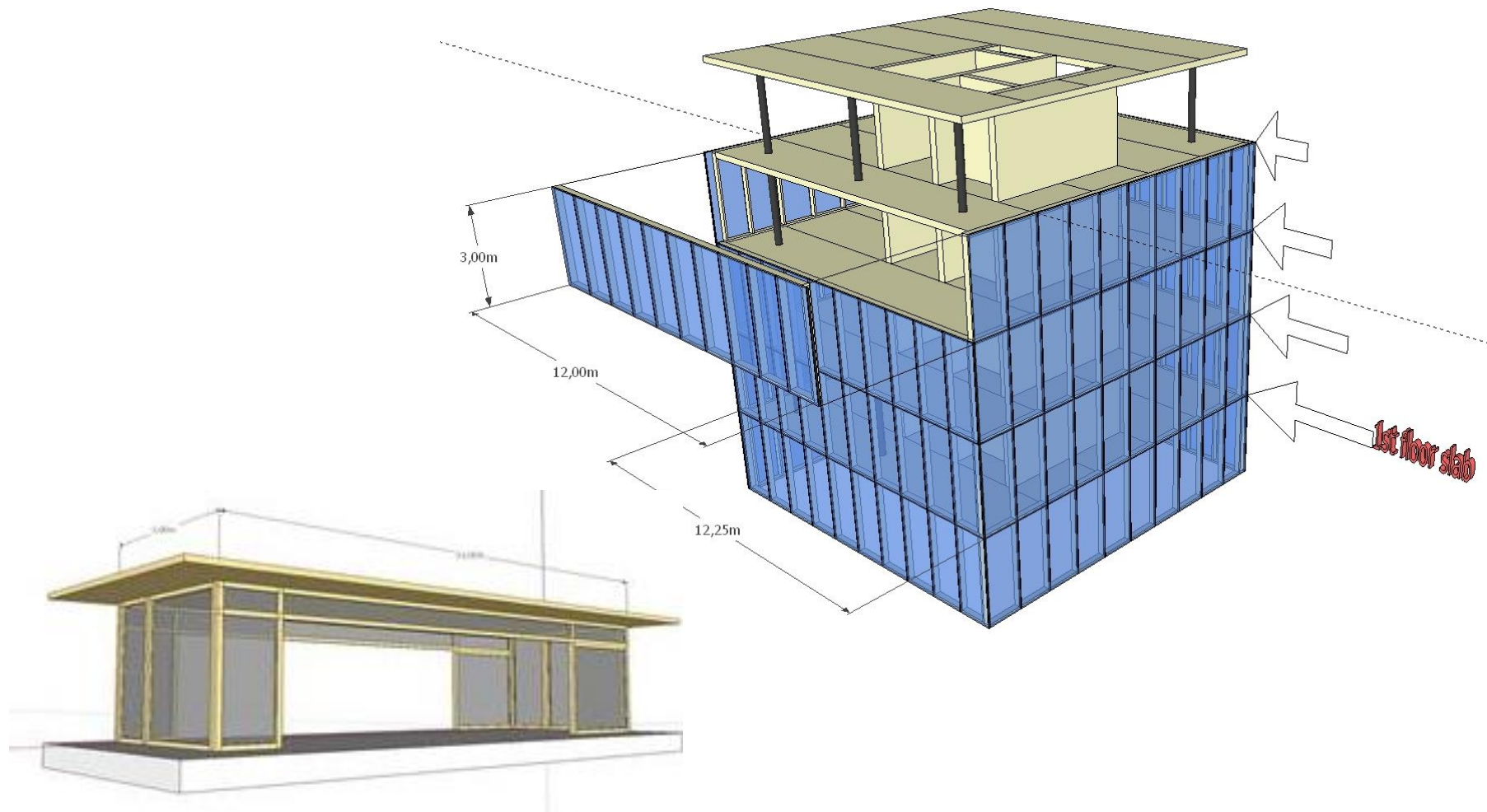

PREISKAVE POSAMEZNIH KONSTRUKCIJSKIH SKLOPOV

Različna eksperimentalna preizkušanja končnih sestavljenih elementov; stebrov, nosilcev, sten.



GLAVNE NALOGE SLOVENSKE EKIPE

- Sodelujemo pri vseh delovnih skupinah
- Vodimo delovni skupini 3 in 6

Večji poudarek na razvoju potresno odporne stekleno-lesene stene, ki bo sposobna disipirati potresno energijo v duktilnih varovalkah.

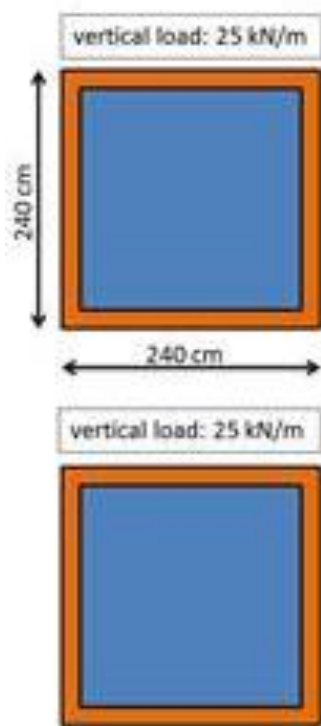

- 1+1 monotonic load test (EN 594:2011)
- 3+3 quasi static cyclic tests (ISO 16670:2003)
- standard measuring positions + optical measurements for glass-frame slip measuring

„L-shaped“ bond line with a blocking system in the corners



„flat“ bond line without blocking



4 x KR 285 hold-downs + additional shear connections

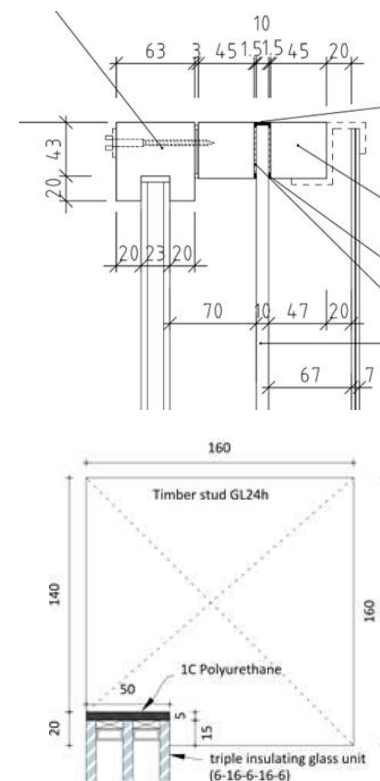
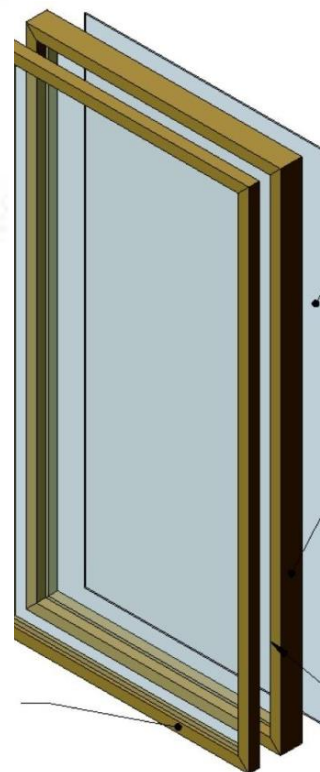

EKSPERIMENTALNE PREISKAVE NA POTRESNI MIZI









EKSPERIMENTALNE PREISKAVE NADGRADNJE OBSTOJEČIH STAVB



GLAVNI PRIČAKOVANI REZULTATI

- Nov inovativen konstrukcijski sistem iz obnovljivih virov
- Enostavnejša rešitev večjih zasteklitev pri potresni obtežbi
- Večanje deleža lesa v gradbeništvu

FINANCIRANJE PROJEKTA

		PRISPEVKI DRŽAV	PRISPEVKI PODJETIJ	SKUPAJ
AVSTRIJA		-	500.000 €	500.000 €
ŠVEDSKA		430.000€	230.000 €	660.000 €
NEMČIJA		414.199 €	-	414.199 €
TURČIJA		160.000 €	-	160.000 €
SLOVENIJA		210.000 €	30.000 €	240.000 €
ČILE		40.000 €	-	40.000 €
BRAZILIJA		20.000 €	23.500 €	53.500 €

SKUPAJ 2.067.699 €



© Thomas Knapp / Architekten Hermann Kaufmann



WoodWisdom-Net

Hvala za pozornost!

dr. Bruno Dujič, Iztok Šušteršič

CBD d.o.o. - Contemporary Building Design

bruno.dujic@cbd.si

www.cbd.si



Univerza v Ljubljani